

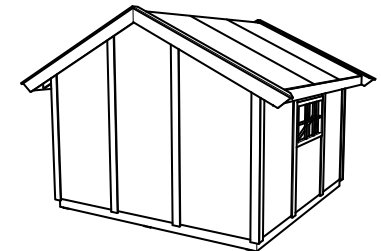

**BYGGMESTER
SKAATUN**

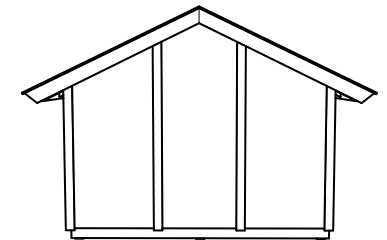

Monteringsveiledning

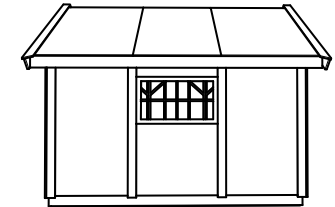
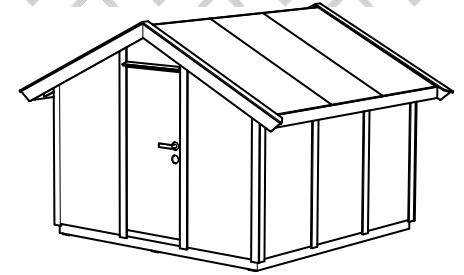
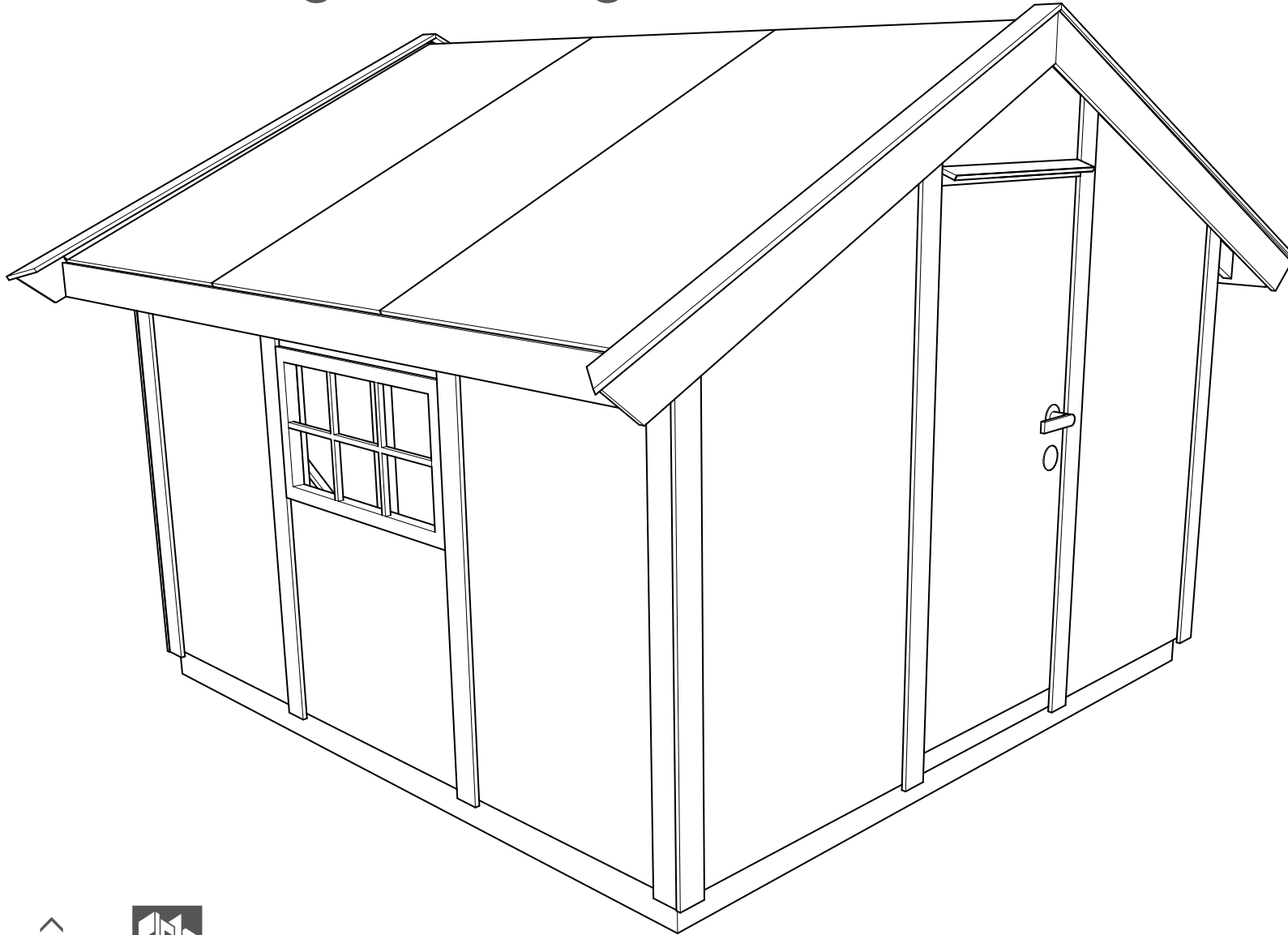



Dette trenger du til monteringen:

Håndsag



Hammer

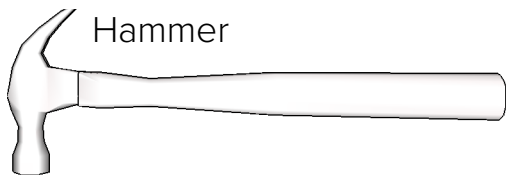

Vater

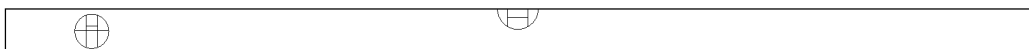

Målebånd / meterstokk

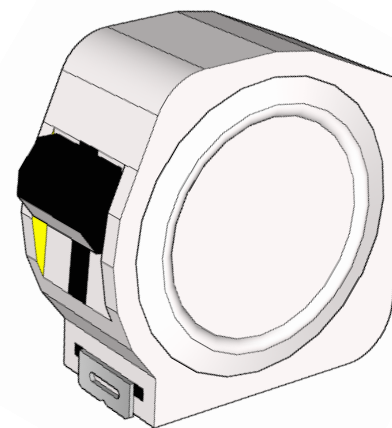

Følgende festemidler følger med byggesettet:

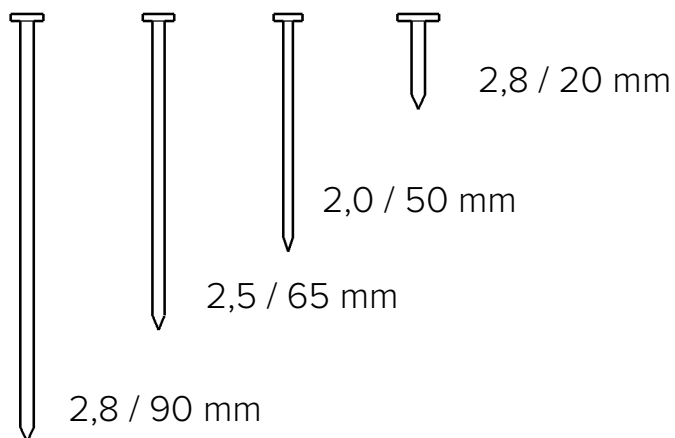

Byggskum til forsegling av skjøter



BYGGMESTER SKAATUN



Monteringsveiledning



Impregnert 2x4 legges ut parallelt med bodens langside, og vates av. Senteravstand fundament: maks 1 meter.

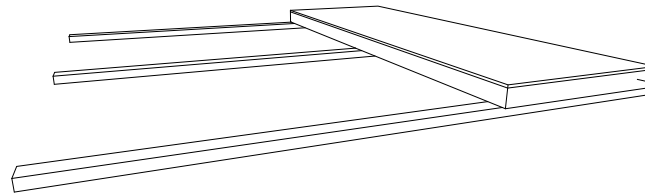

Gulvseksjon flukter med enden av impregnert 2x4.

Langs langsidenes trekkes 2x4 20 mm inn under gulvseksjonene.

Gulvseksjonene festes innbyrdes og til 2x4 under montering.

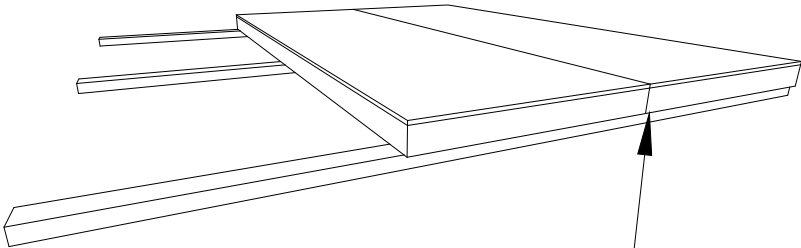
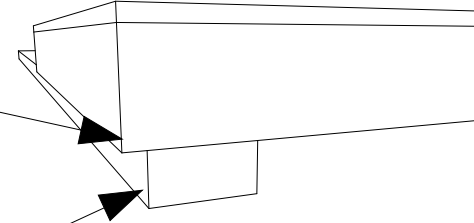

Dersom gulvet er i isolert utførelse, legges det en stripe med skum mellom gulvseksjonene.

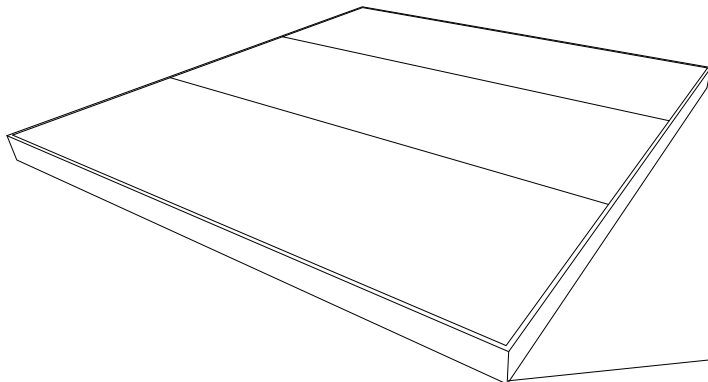
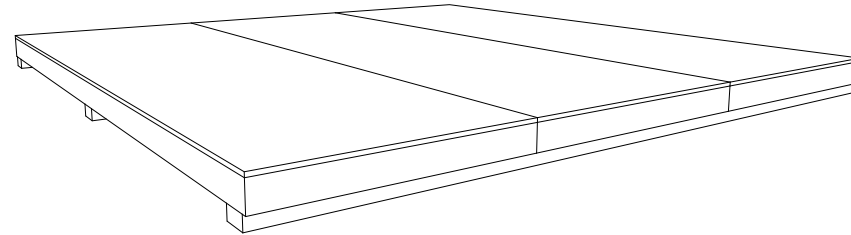

Impregnert sokkelbord monteres jevnt med overkant gulv - langside overlapper sokkelbord gavlside og kappes jevnt i ytterkant. Bruk 2,5/65 spiker.

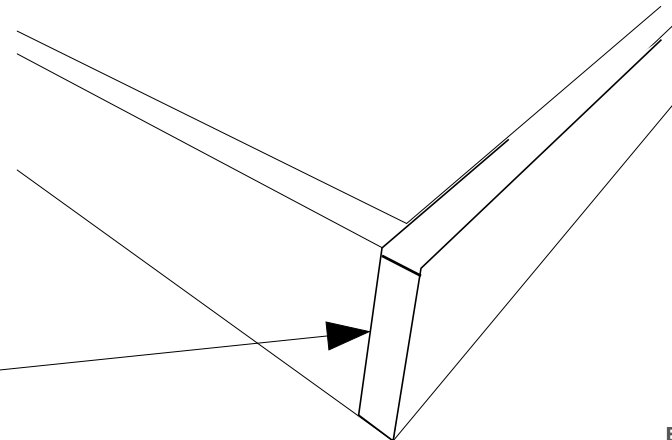



BYGGMESTER SKAATUN

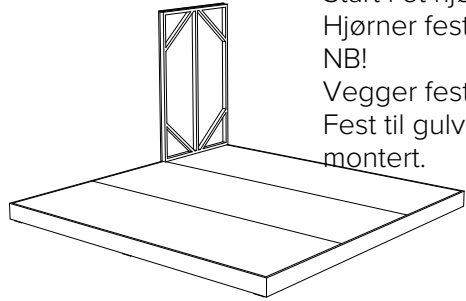

Start i et hjørne.
Hjørner festes utenfra med 2,0/50 spiker.
NB!
Vegger festes først innbyrdes.
Fest til gulv etter at takseksjoner
montert.

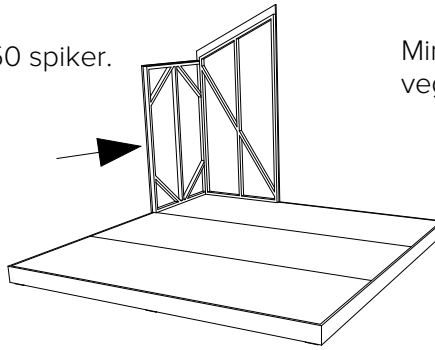

Min 3 stk. 2,5/65 spiker pr.
veggsammenføring

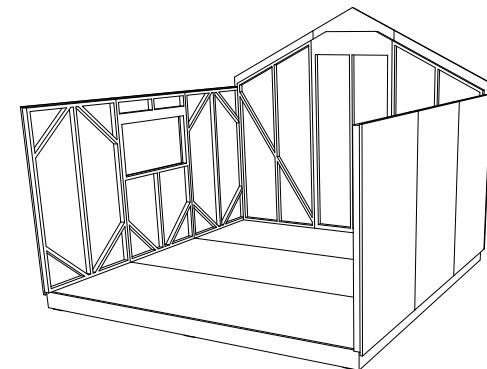
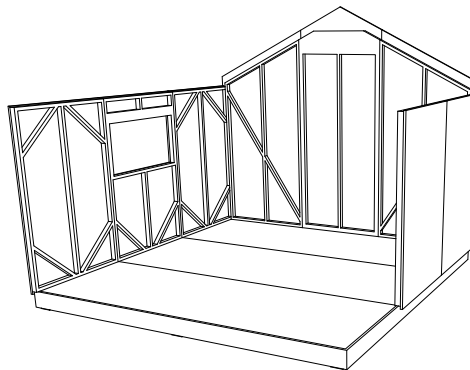
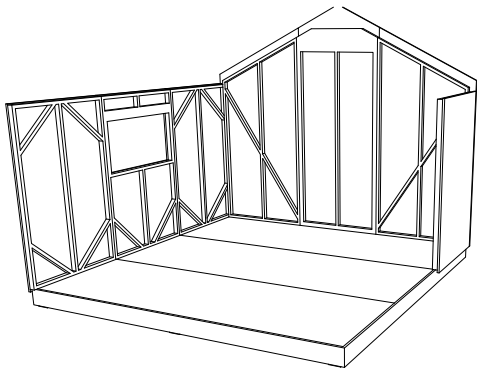
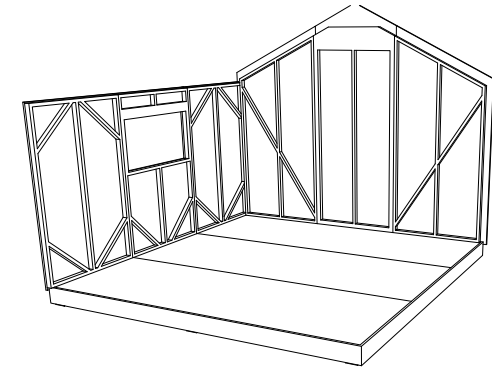
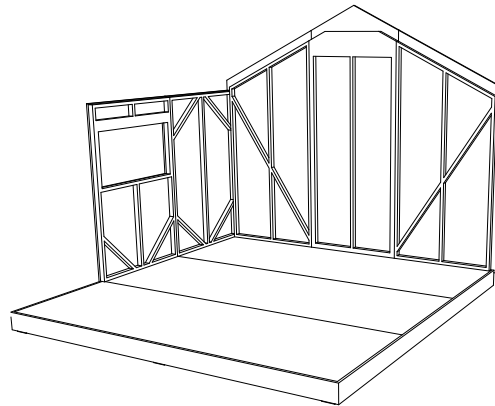
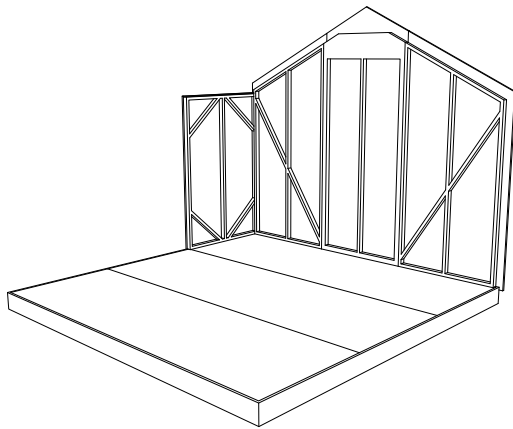
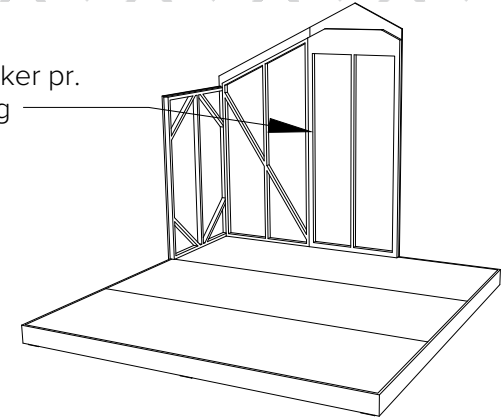

Monteringsveiledning

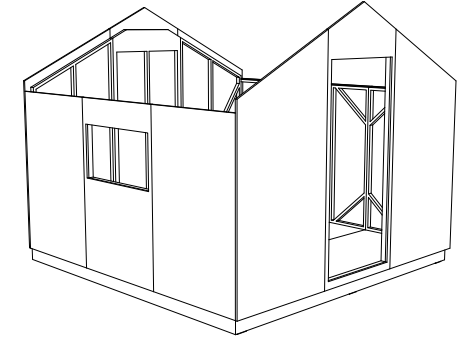
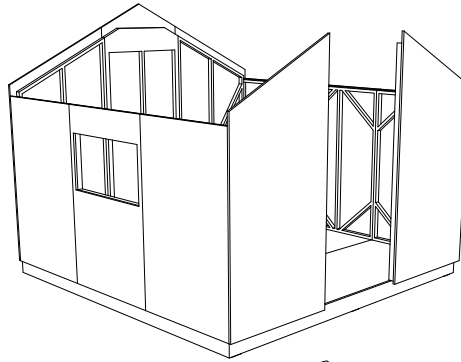
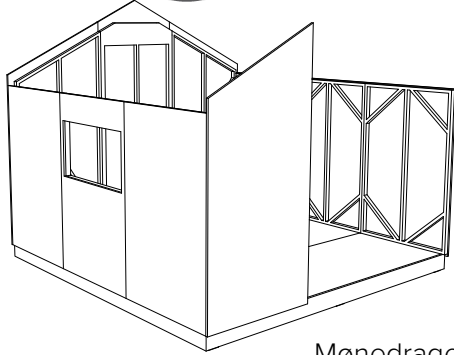

Mønedrager monteres
sentrisk i hver gavl
Stikkspikres med 2,8/90 spiker

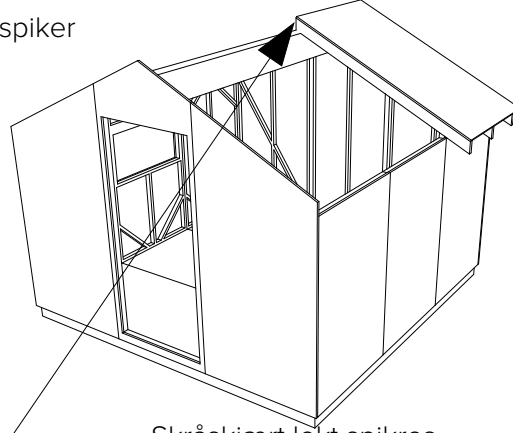
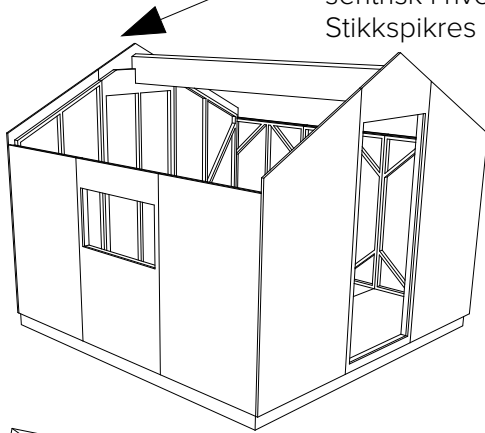

Skråskjært lekt spikres
til topprammen på langveggene

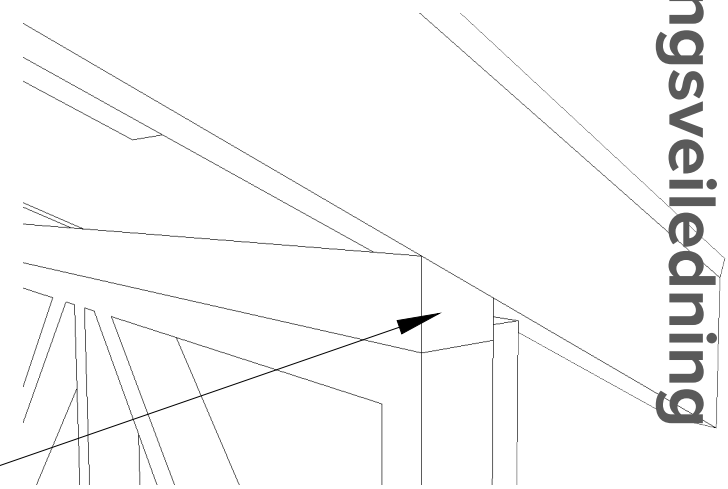

Takseksjoner:

Skråskjært lekt støtter mot kledningen som stikker over rammen på langveggene.
I mønet skal takseksjonene følge mønelinjen på drager.

NB! takseksjonene skal monteres slik at sperreendene ligger kant i kant.
Seksjonene festes innbyrdes, i mønedrager og vegger.
Stikkspikres til drager med 2,8/90 spiker, og til tilstøtende takseksjon
med 2,5/65 spiker.



BYGGMESTER SKAATUN

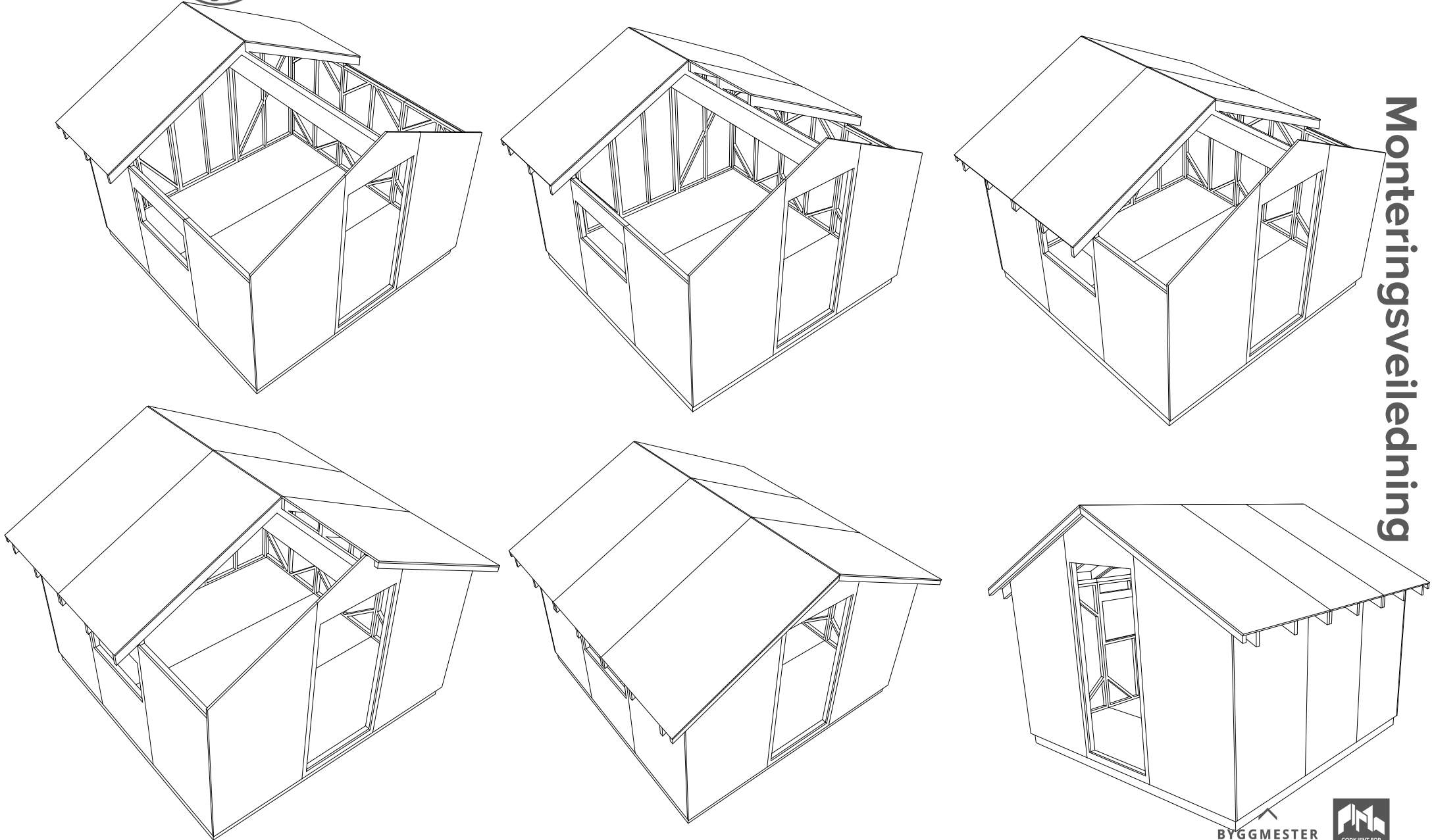

Monteringsveiledning



BYGGMESTER SKAATUN

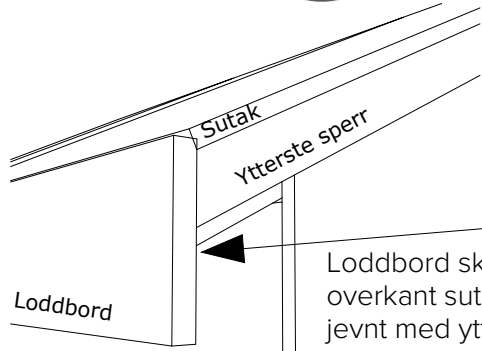

Loddbord skal flukte med overkant sutak, og kappes jevnt med ytterste sperr i hver ende. Bruk 2,5/65 spiker.

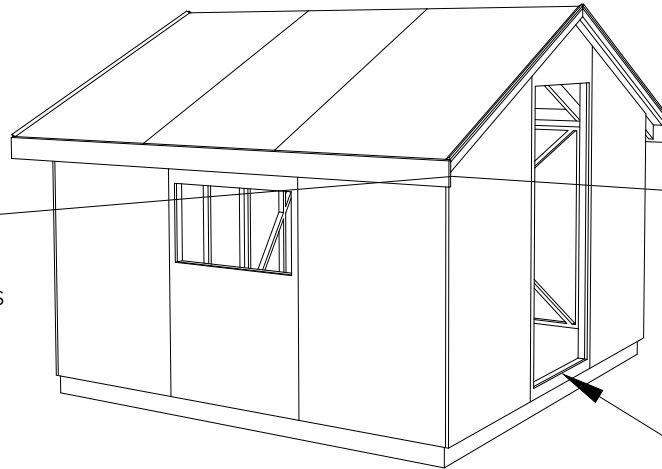

Skrålist monteres ytterst på sutak på alle utstikk

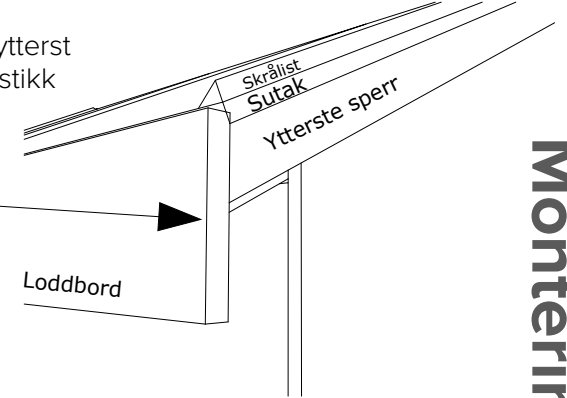

Ramme kuttes før dørmontering

Neste steg blir å legge Shingel.
Første strekk skal ha en 15 mm dryppkant utenfor loddbord.
-følg monteringsanvisningen på emballasjen fra produsent.
Shingel festes med 2,8/20 pappspiker.

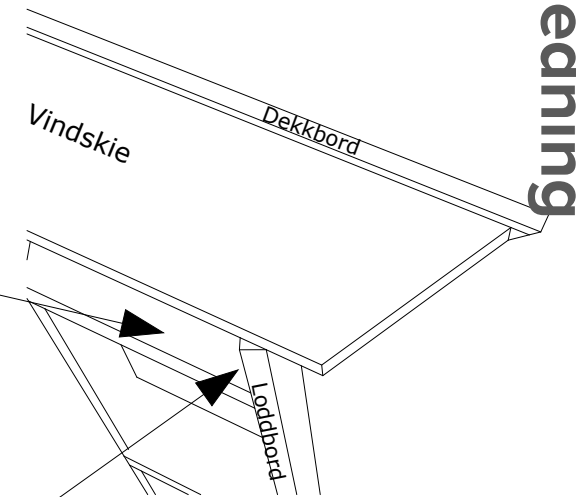
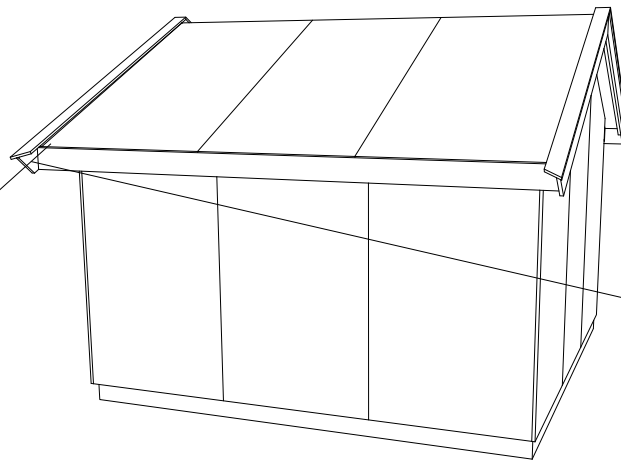
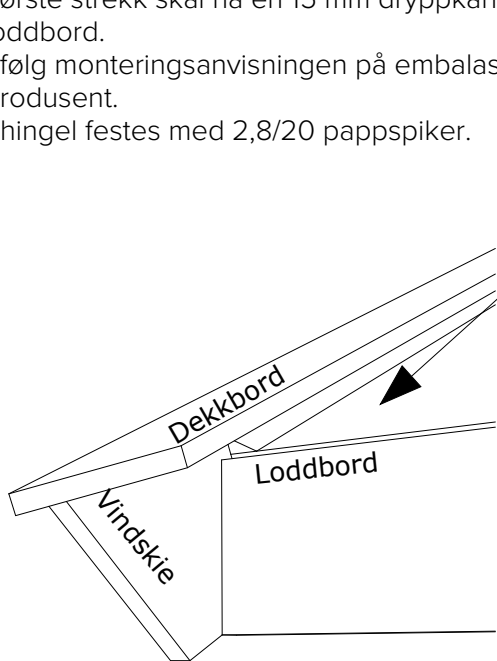

Vindskie kant i kant med underkant loddbord

Monteringsveiledning

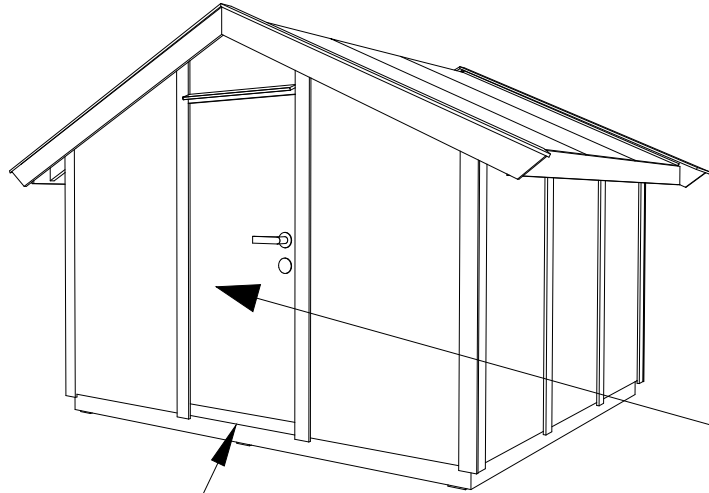

List med pakning monteres under dørterskel etter at døren er montert.

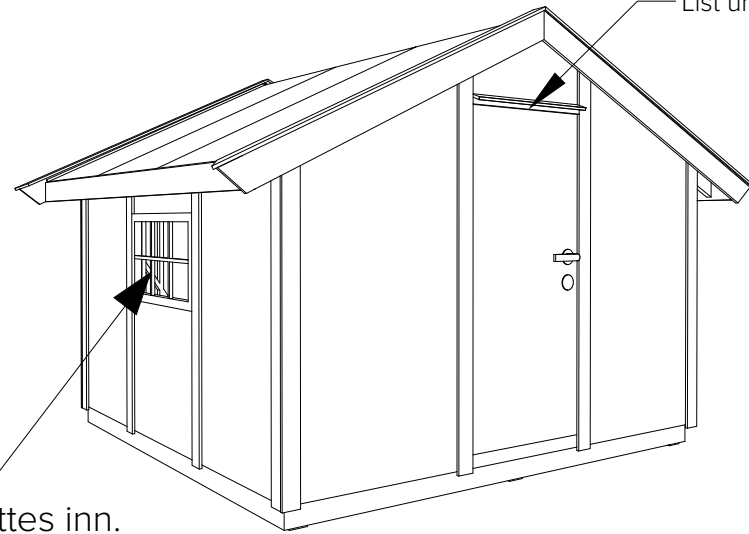

List under vannbord.

Dør og vindu settes inn.
Legg skum i skjøter før lister monteres.
Listverk og vindu festes med 2,0/50 spiker

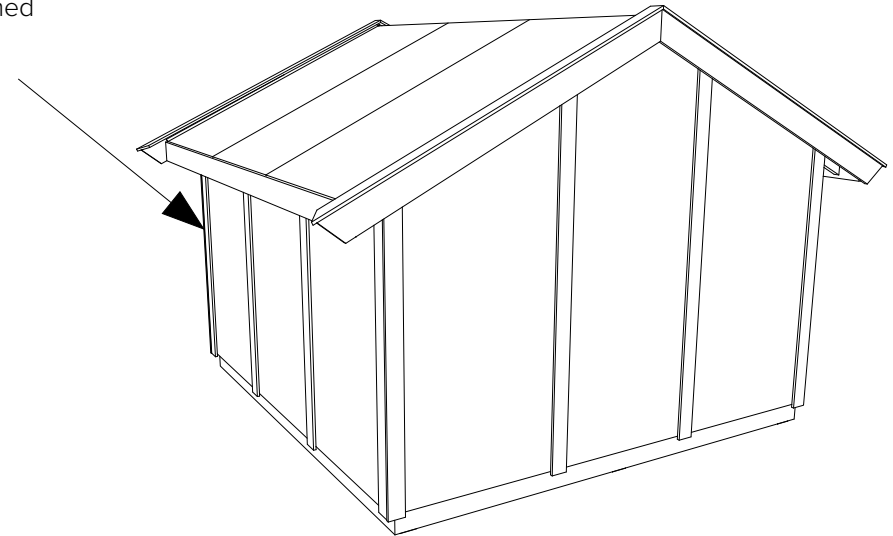
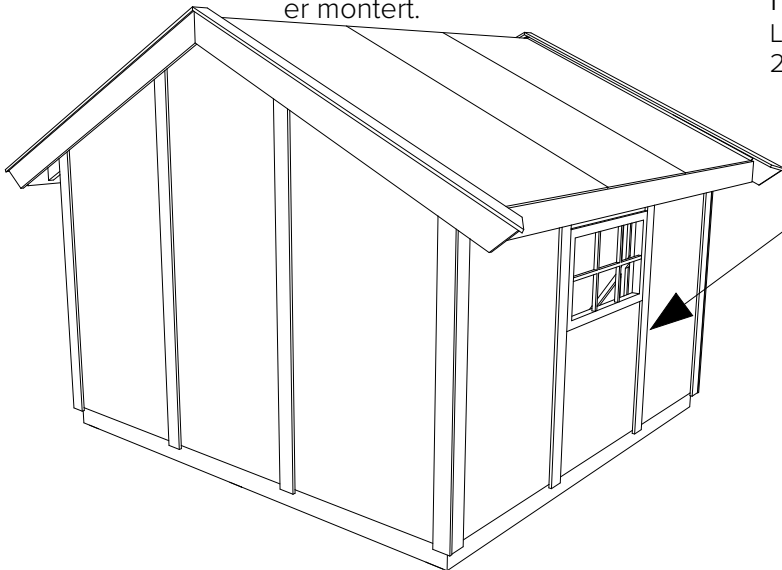

-Gratulerer med ditt nye eksemplar av SkaatunBoden